

### Features

- Allows Kohler Invigoration® Steam Generator to be controlled via the DTV+ Showering System.
- For use with Kohler Invigoration® Steam Generators between 18 and 30 kilowatts.
- Adjustable temperature settings between 90°F and 125°F.
- Aromatherapy reservoir on steam heads.
- Includes two steam heads, temperature sensor, and adapter.
- Circular steam head design allows steam to be evenly dispensed throughout shower.
- 20-minute safety shutoff.
- Quick-connect RJ-12 cord and connector for simplified installation and service.
- Not compatible with other manufacturers' steam generators.

### Material

- KOHLER finishes resist corrosion and tarnishing.

### Installation

- Requires DTV+ shower components (sold separately).

### Required Products/Accessories

K-5539 18kW steam generator

or

K-5543 22kW steam generator

or

K-5546 26kW steam generator

or

K-5547 30kW steam generator

### Included Components

Additional Components:

10" straight cable

16" crossover cable

6" straight cable

DTV harness

Dual connector

Gasket

Mounting arm

Steamhead assembly (Qty 2)

Terminator

Thermostor harness



### Codes/Standards









None Applicable

### KOHLER® Electronic Faucets, Valves, and Controls Five-Year Limited Warranty

See website for detailed warranty information.

### Available Colors/Finishes

*Color tiles intended for reference only.*

Color	Code	Description
	CP	Polished Chrome
	SN	Vibrant® Polished Nickel
	BN	Vibrant® Brushed Nickel
	BV	Vibrant® Brushed Bronze
	2BZ	Oil-Rubbed Bronze
	BL	Matte Black
	2MB	Vibrant® Brushed Moderne Brass
	TT	Vibrant Titanium

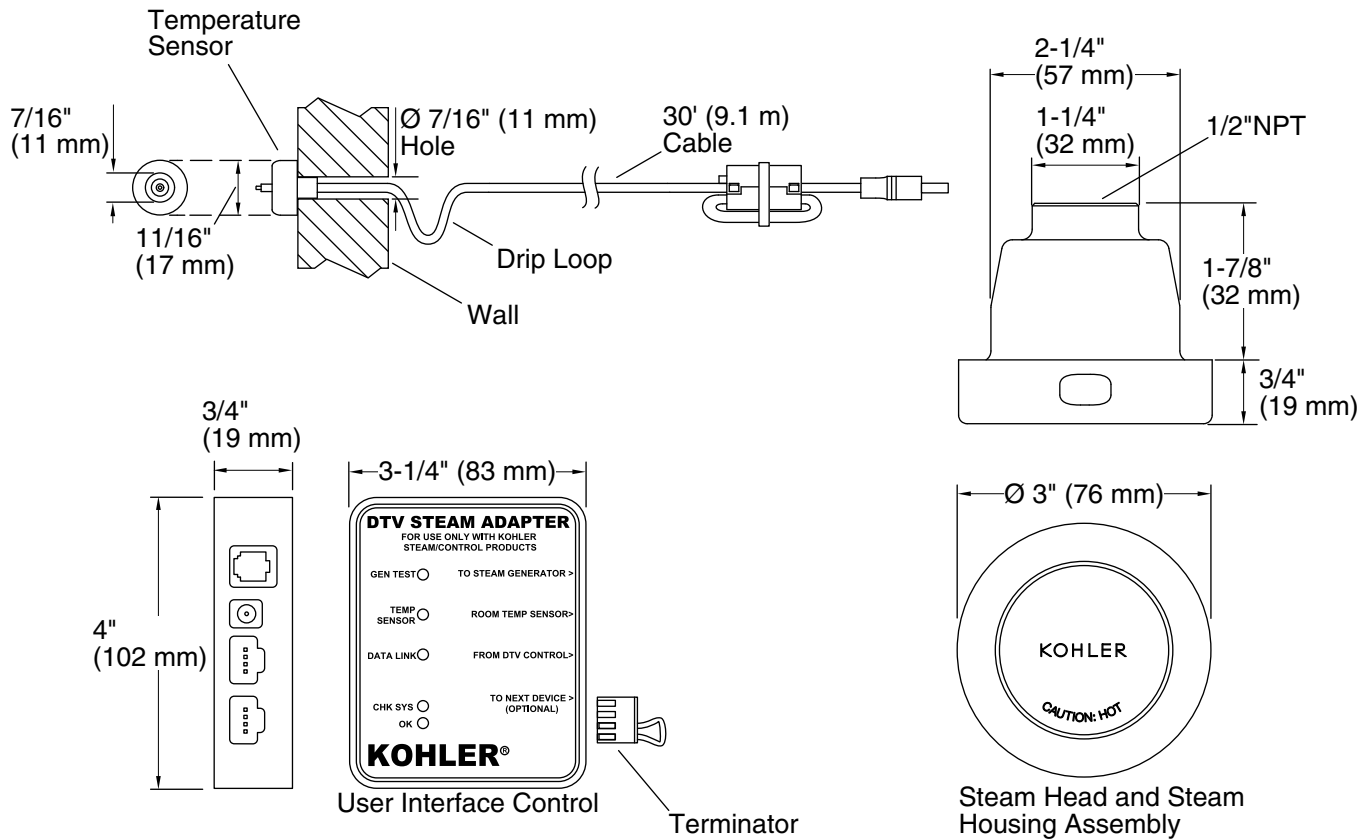

**Technical Information**

All product dimensions are nominal.

Drain included: No

**Notes**

Install this product according to the installation guide.

**CAUTION:** Risk of scalding. Do not locate the steam head near a seat or bench, as the steam head is hot during operation and may scald the user if touched.

The temperature sensor should be mounted on the wall opposite the steam head. The steam head should be located as far from the seating area as possible.

Locate the steam head 6" (152 mm) above the floor and at least 4-1/2" (114 mm) from the threshold.