

Features

- Allows KOHLER® Invigoration® steam generator to be controlled via the DTV+™ and Anthem+™ digital showering systems
- For use with Kohler Invigoration® Series steam generators between 5 and 15 kilowatts
- Adjustable temperature settings between 90°F and 125°F
- Aromatherapy reservoir on steam heads
- Includes steam head, temperature sensor, and adapter
- Circular steam head design allows steam to be evenly dispensed throughout shower
- 20-minute safety shutoff
- Quick-connect RJ-12 cord and connector for simplified installation and service
- Not compatible with other manufacturers' steam generators
- Requires DTV+™ or Anthem+™ showering components (sold separately)

Material

- KOHLER® finishes resist corrosion and tarnishing

Required Products/Accessories

K-5525 5 kW steam generator

or

K-5526 7 kW steam generator

or

K-5529 9 kW steam generator

or

K-5533 13 kW steam generator

or

K-5535 15 kW steam generator

or

K-27756 System controller module

or

K-28214-ASC Digital control



Codes/Standards







None Applicable

KOHLER® Electronic Faucets, Valves, and Controls Five-Year Limited Warranty

See website for detailed warranty information.

Available Colors/Finishes

Color tiles intended for reference only.

Color	Code	Description
	CP	Polished Chrome
	SN	Vibrant® Polished Nickel
	AF	Vibrant® French Gold
	BN	Vibrant® Brushed Nickel
	BV	Vibrant® Brushed Bronze
	BL	Matte Black
	2MB	Vibrant® Brushed Moderne Brass
	TT	Vibrant Titanium

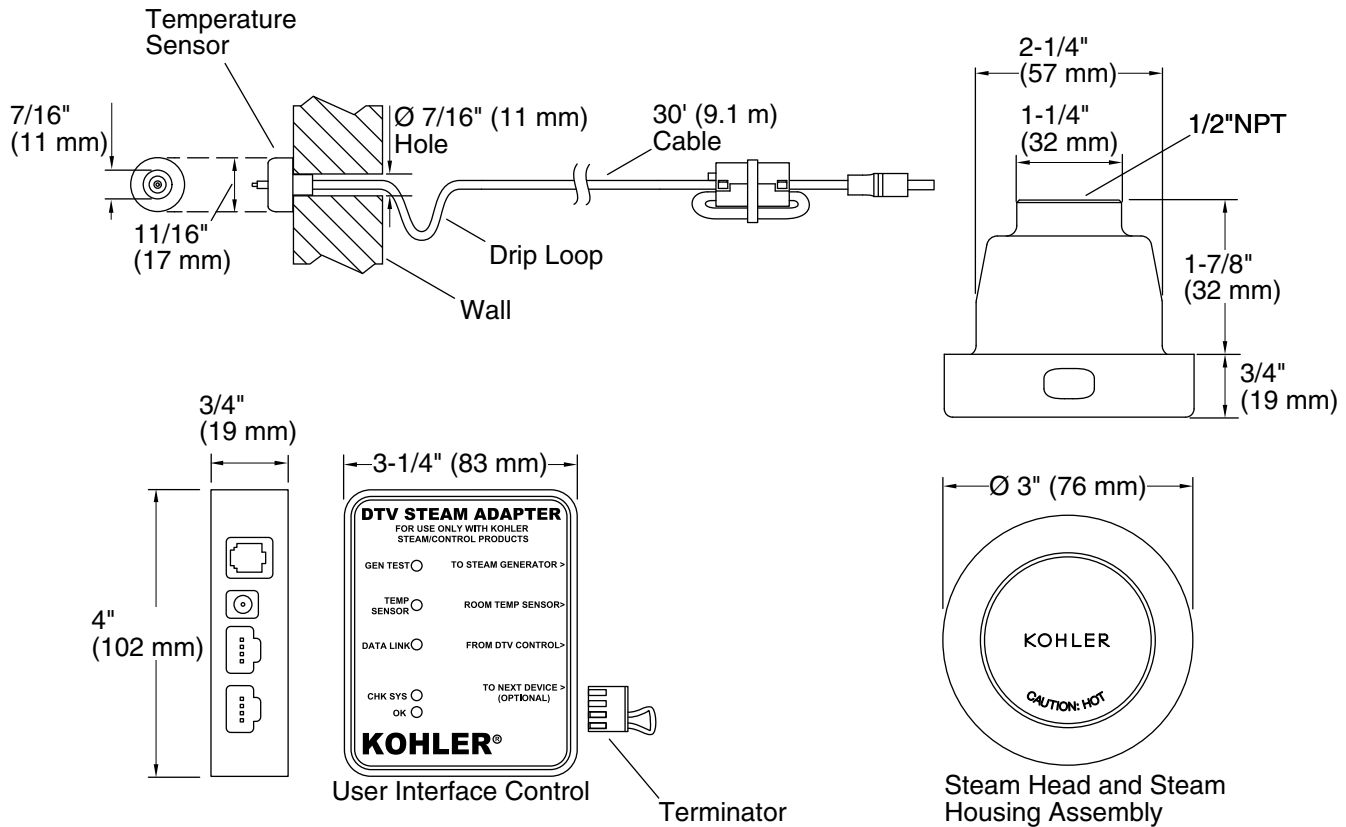

Technical Information

All product dimensions are nominal.

Drain included: No

Handshower:

Rated maximum flow: 0 gal/min (0 l/min)

Notes

Install this product according to the installation guide.

CAUTION: Risk of scalding. Do not locate the steam head near a seat or bench, as the steam head is hot during operation and may scald the user if touched.

The temperature sensor should be mounted on the wall opposite the steam head. The steam head should be located as far from the seating area as possible.

Locate the steam head 6" (152 mm) above the floor and at least 4-1/2" (114 mm) from the threshold.