

Features

- Bell-shaped shades in seeded glass combine with exposed cording, knurled metal, and a tanned leather strap for a modern industrial yet refined feel
- Requires bulbs with medium (E26) base; type A19 bulb recommended (sold separately)
- Suitable for damp locations, per UL 1598
- Includes installation hardware
- Fixture is dimmable when paired with dimmer switch and compatible bulbs

Material

- Premium metal, glass, and leather construction
- Manufactured with quality materials and complemented with a meticulous finishing process
- Durable finishes engineered to last and designed to coordinate with KOHLER faucet finishes

Installation

- Wall-mount



Codes/Standards

UL 1598
CSA C22.2 No. 250.0

KOHLER® Indoor Lighting Fixtures Limited Warranty

See website for detailed warranty information.

Available Colors/Finishes

Color tiles intended for reference only.

Color	Code	Description
	BNL	Brushed Nickel
	CPL	Polished Chrome
	BML	Black, Brass Trim

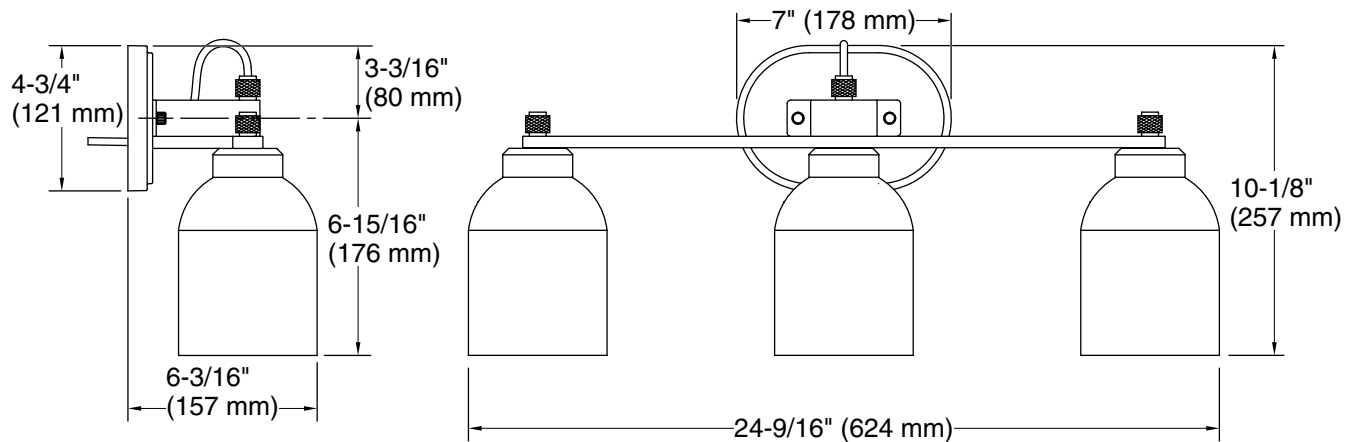

Required Electrical Service

One circuit required.

120 V, 1 A, 60 Hz

Technical Information

All product dimensions are nominal.

Material:	Steel, Aluminum, Glass
Number of Lights:	3
Lighting Type:	Socket-based
Socket Type:	E-26 Medium
Number of Shades:	3
Shade Type:	Seeded Glass
Hanging Type:	Non-hanging
Height:	10" (254 mm) - 10-1/4" (260 mm)

Notes

Install this product according to the installation instructions.