



Features

- 120 airjets release thousands of bubbles that surround, support, and massage the body.
- Variable-speed blower lets you adjust massage intensity to 18 levels.
- Corner layout minimizes footprint without compromising bathing area.
- Spacious design accommodates up to two bathers.
- Molded lumbar supports and armrests offer extra comfort while bathing.
- Center drain.

Material

- Acrylic

Hydrotherapy

- BubbleMassage

Installation

- Drop-in

Additional Hydrotherapy Options

- Soaking Bath - K-1161-0
- Whirlpool - K-1160-0
- Whirlpool + heater - K-1160-H

Recommended Products/Accessories

- K-11677 Bath Drain
- K-1491 Bath/Whirlpool Pillow
- K-1446 Remote Installation Kit
- K-1601 Bath/Whirlpool Footstop
- K-7259 Clearflo Bath Drain
- K-9497 2-1/2" Keypad Trim
- K-37382 45" Rough-in Cable Bath Drain



Codes/Standards

- ASME A112.19.7/CSA B45.10
- CSA B45.5/IAPMO Z124
- ASTM E162
- ASTM E662
- UL 1795
- Greenguard UL 2818 - Gold



**KOHLER® Plastic Baths and Receptors
Lifetime Limited Warranty
KOHLER® Hydrotherapy Components
Five-Year Limited Warranty**

See website for detailed warranty information.

Available Colors/Finishes

Color tiles intended for reference only.

Color Code Description

	0	White
	96	Biscuit
	47	Almond

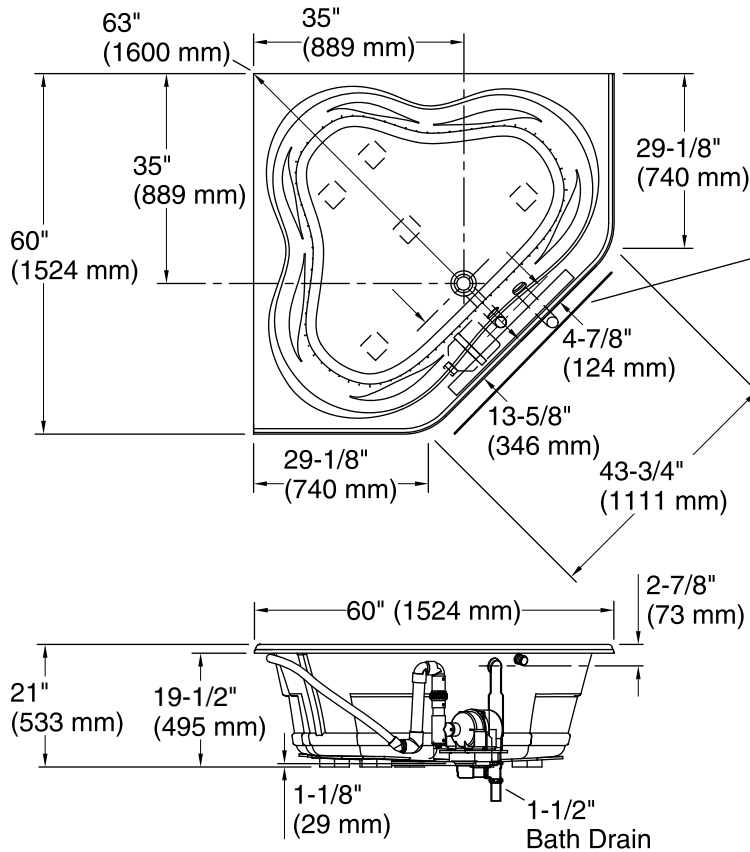

No change in measurements if connected with drain illustrated. (K-11677)

 Recommended Faucet Location

Blower/Control Access
20" (508 mm) W x
15" (381 mm) H

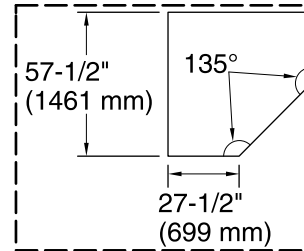

Drop-In Rim Style
Cut-Out Detail

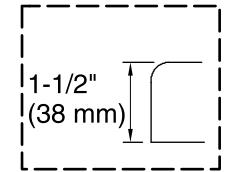

Drop-in Rim Detail

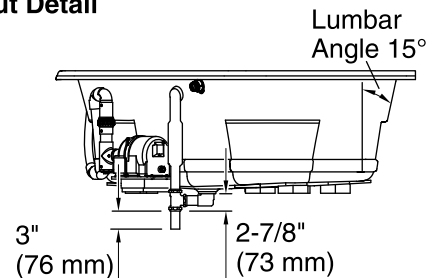

Required Electrical Service

One dedicated circuit required, protected with Class A Ground-Fault Circuit-Interrupter (GFCI). Outside North America, this device may be known as a Residual Current Device (RCD).

Blower: 120 V, 15 A, 60 Hz

Technical Information

All product dimensions are nominal.

Installation:	Drop-in
Drain location:	Center
Basin area, bottom:	52" x 38-3/4" (1321 mm x 984 mm)
Basin area, top:	61" x 46-1/4" (1549 mm x 1175 mm)
Weight:	127 lbs (57.6 kg)
Minimum floor load:	39 lbs/ft ² (190.4 kg/m ²)
Water depth:	15" (381 mm)
Water capacity:	96 gal (363.4 L)
Electrical component rating:	Blower: 120 V, 10 A, 60 Hz

Notes

Measure your actual product for rough-in details. Install this product according to the installation instructions.

The hot water supply should be 70% of the capacity of the bath or greater. Installations will vary.

Remote blower installation kit is available for relocating the blower. Provide access for servicing the blower.

Do not relocate or alter the PVC tee or coiled flexible tubing connected to the blower. Follow the blower relocation instructions exactly.

If installing a rim-mount faucet, make sure there is no interference above or below the deck before drilling any holes.